

PLAN

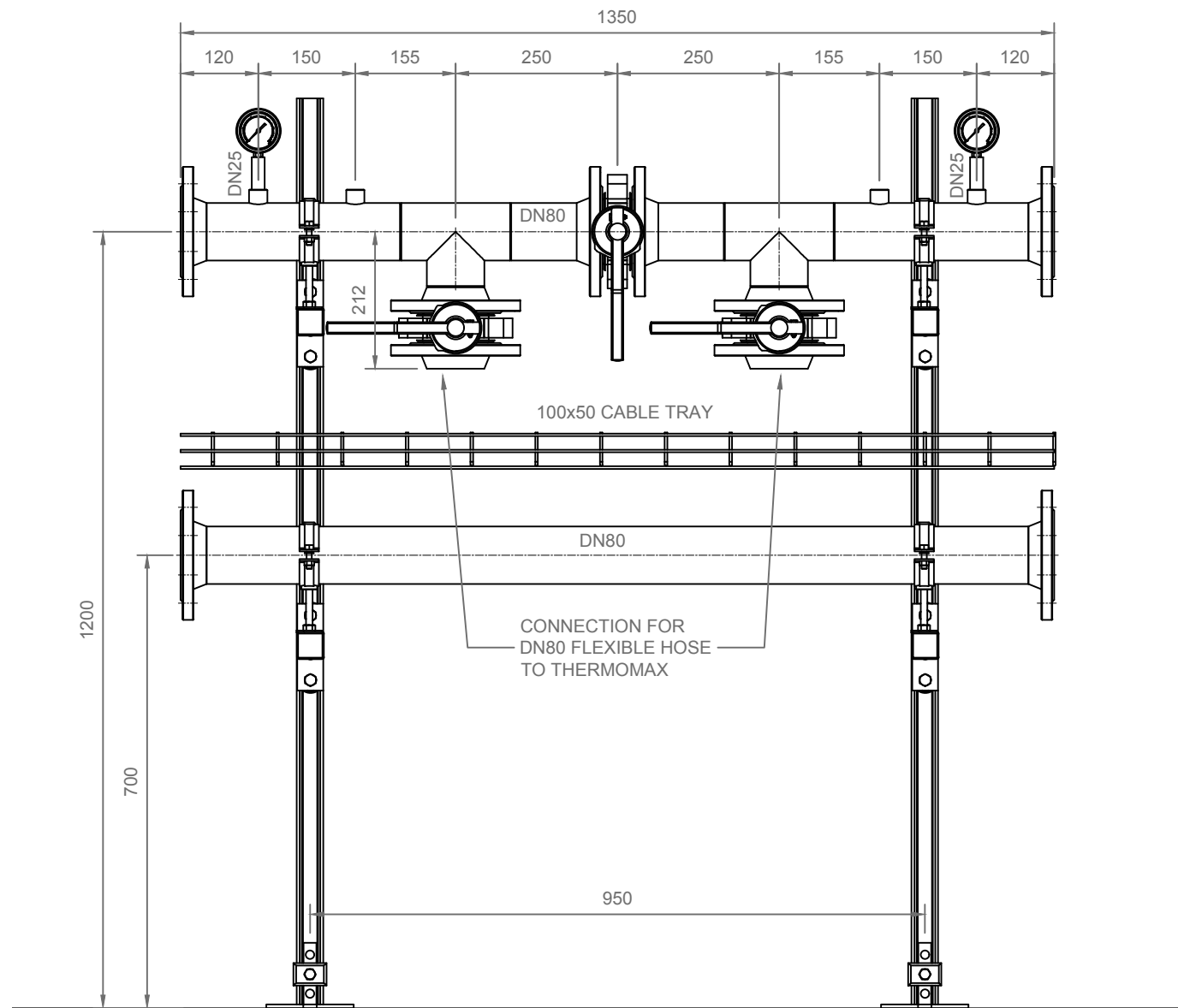

ELEVATION

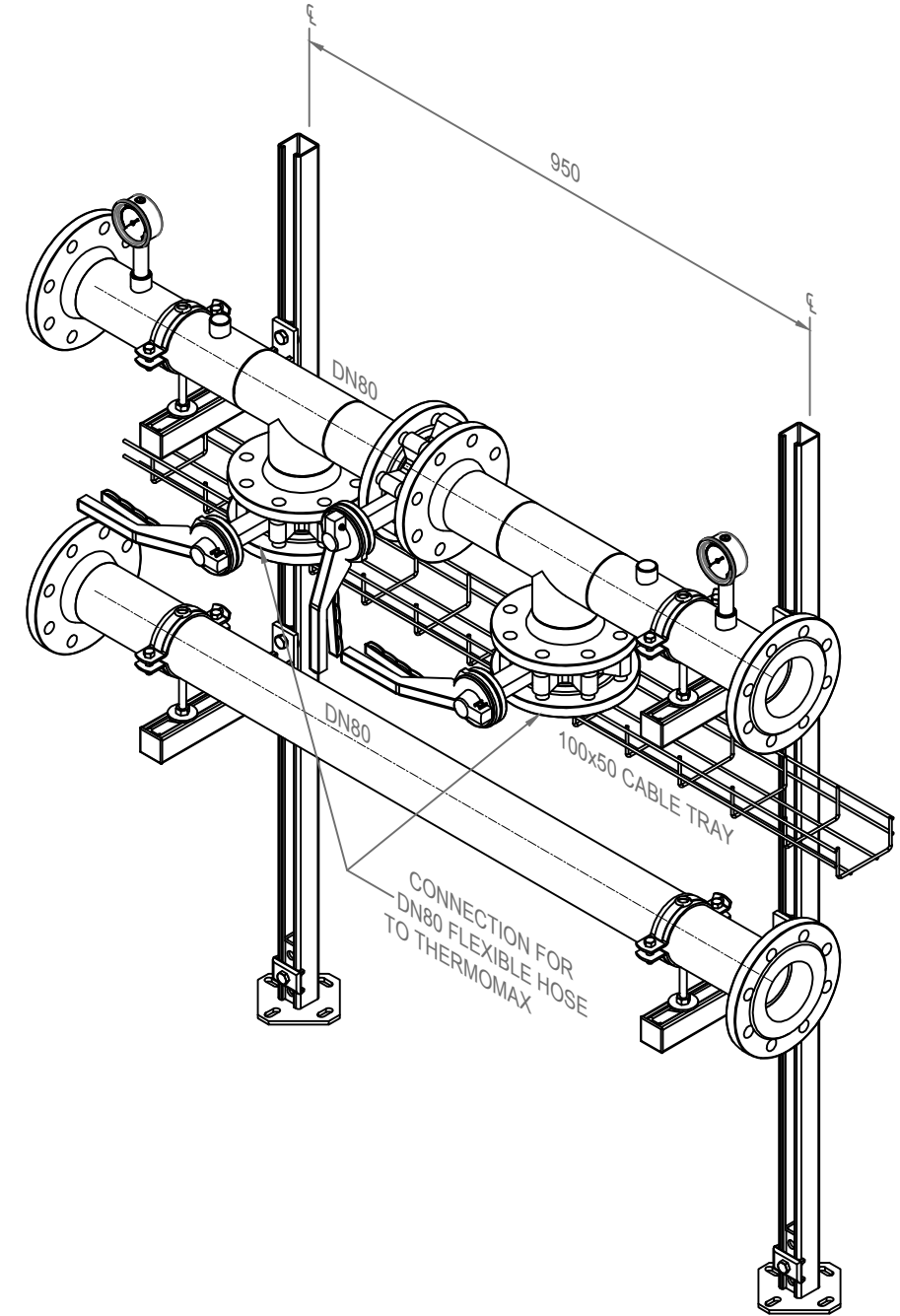

NOTE: ALL DIMENSIONS ARE IN MM UNLESS OTHERWISE STATED.



DRAWN:
ALIHASAN
CHECKED:
DATE:
10-31-2018

MODULE - 3
SKID GENERAL ARRANGEMENT

REV	DATE	DESCRIPTION	DRAWING NO.
			DWG-003
SCALE			1:10

A3 ORIGINAL SIZE