

PLAN

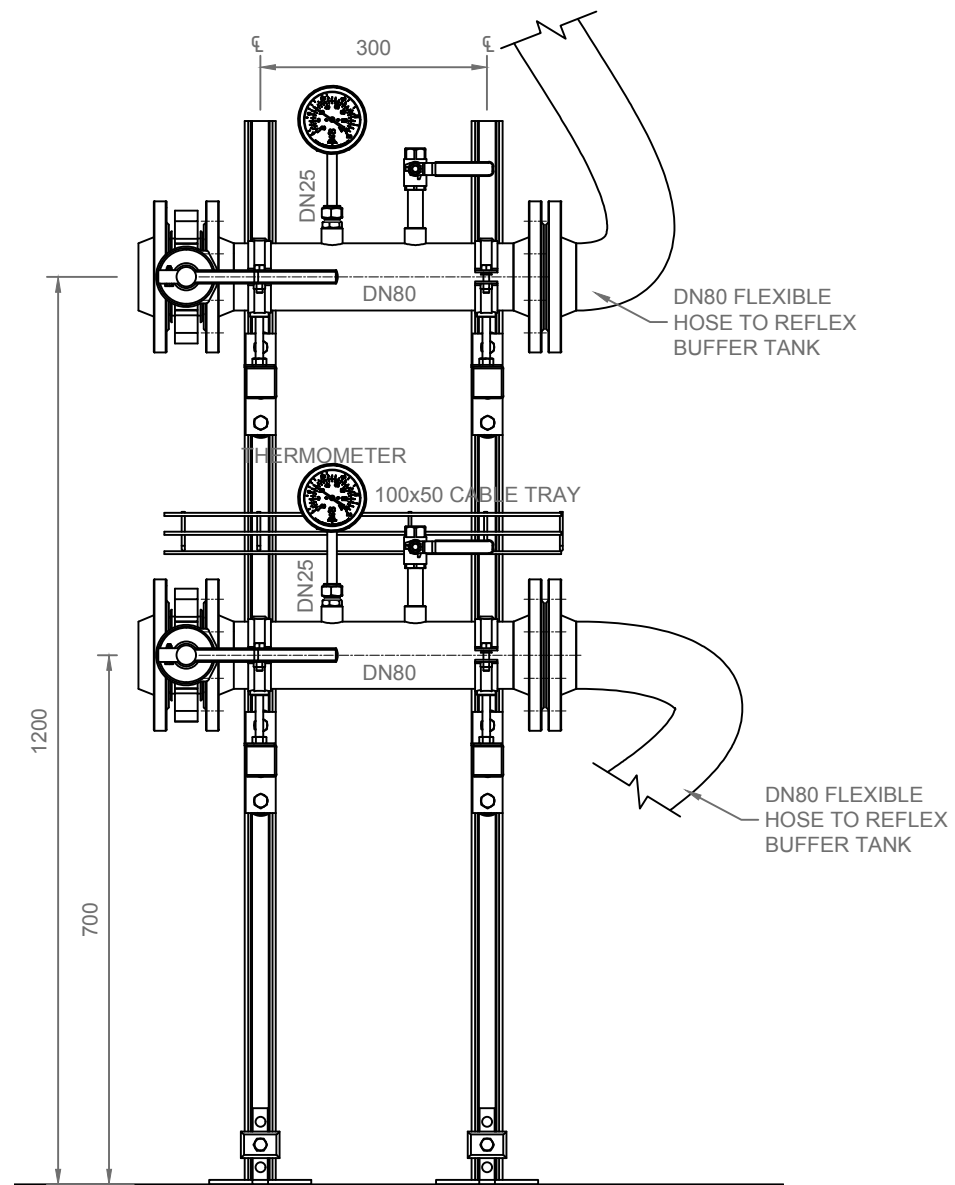

ELEVATION

NOTE: ALL DIMENSIONS ARE IN MM UNLESS OTHERWISE STATED.

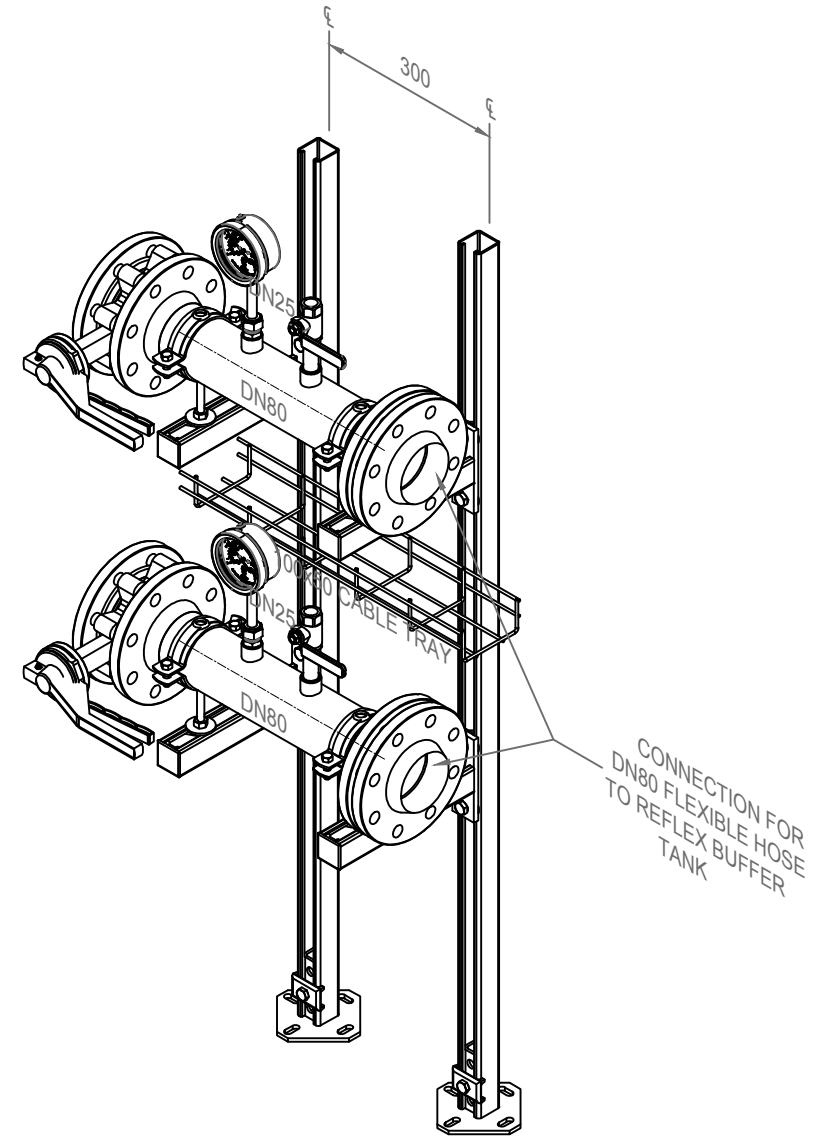

DRAWN:
ALIHASAN
CHECKED:
DATE:
10-31-2018

MODULE - 2
SKID GENERAL ARRANGEMENT

REV	DATE	DESCRIPTION

DRAWING NO.
DWG-002
SCALE
1:10