

PLAN

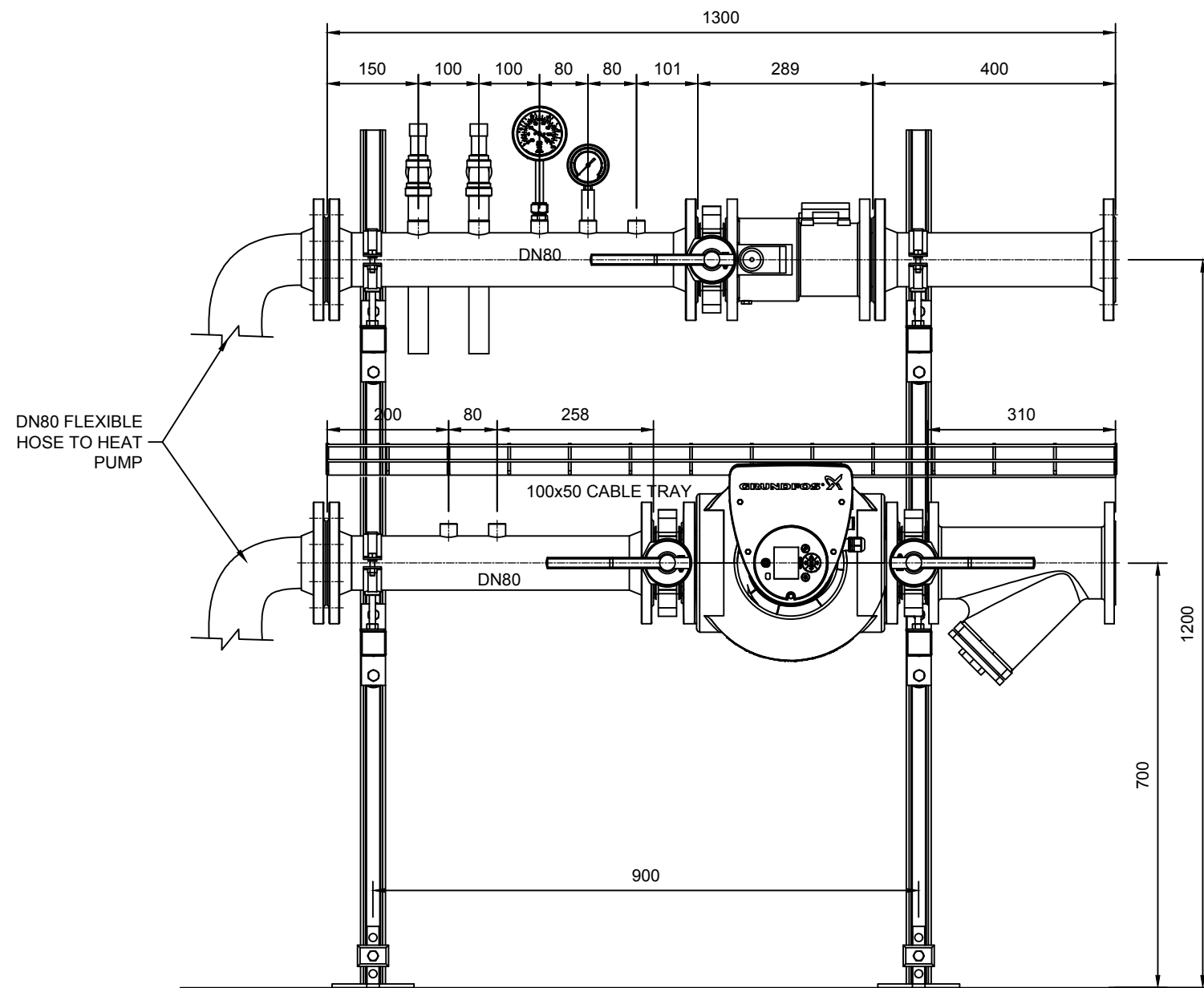

ELEVATION

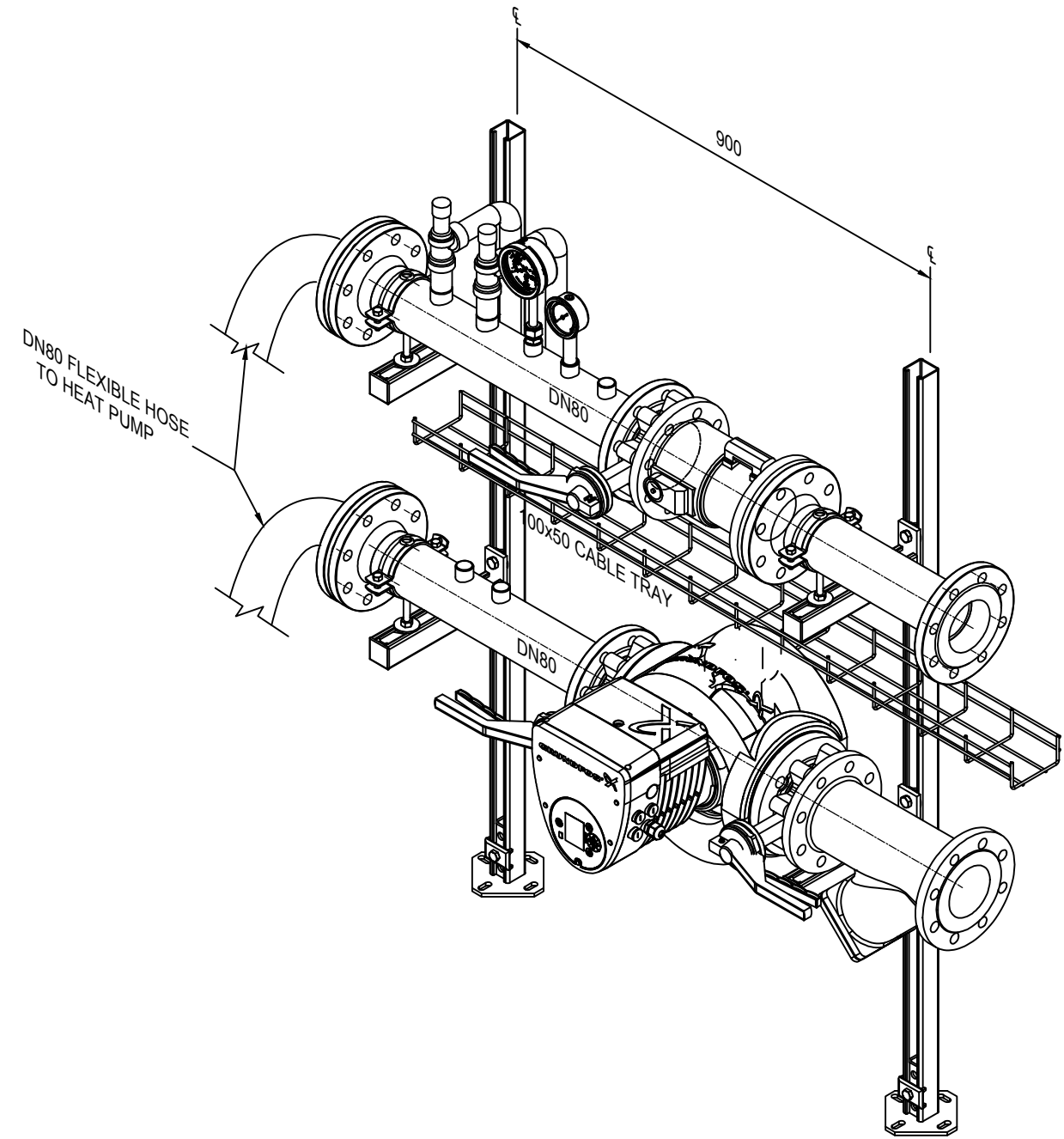

NOTE: ALL DIMENSIONS ARE IN MM UNLESS OTHERWISE STATED.



DRAWN:  
ALIHASAN  
CHECKED:  
DATE:  
10-31-2018

MODULE - 1  
SKID GENERAL ARRANGEMENT

REV	DATE	DESCRIPTION	DRAWING NO.
			DWG-001
			SCALE 1:10