

PLAN

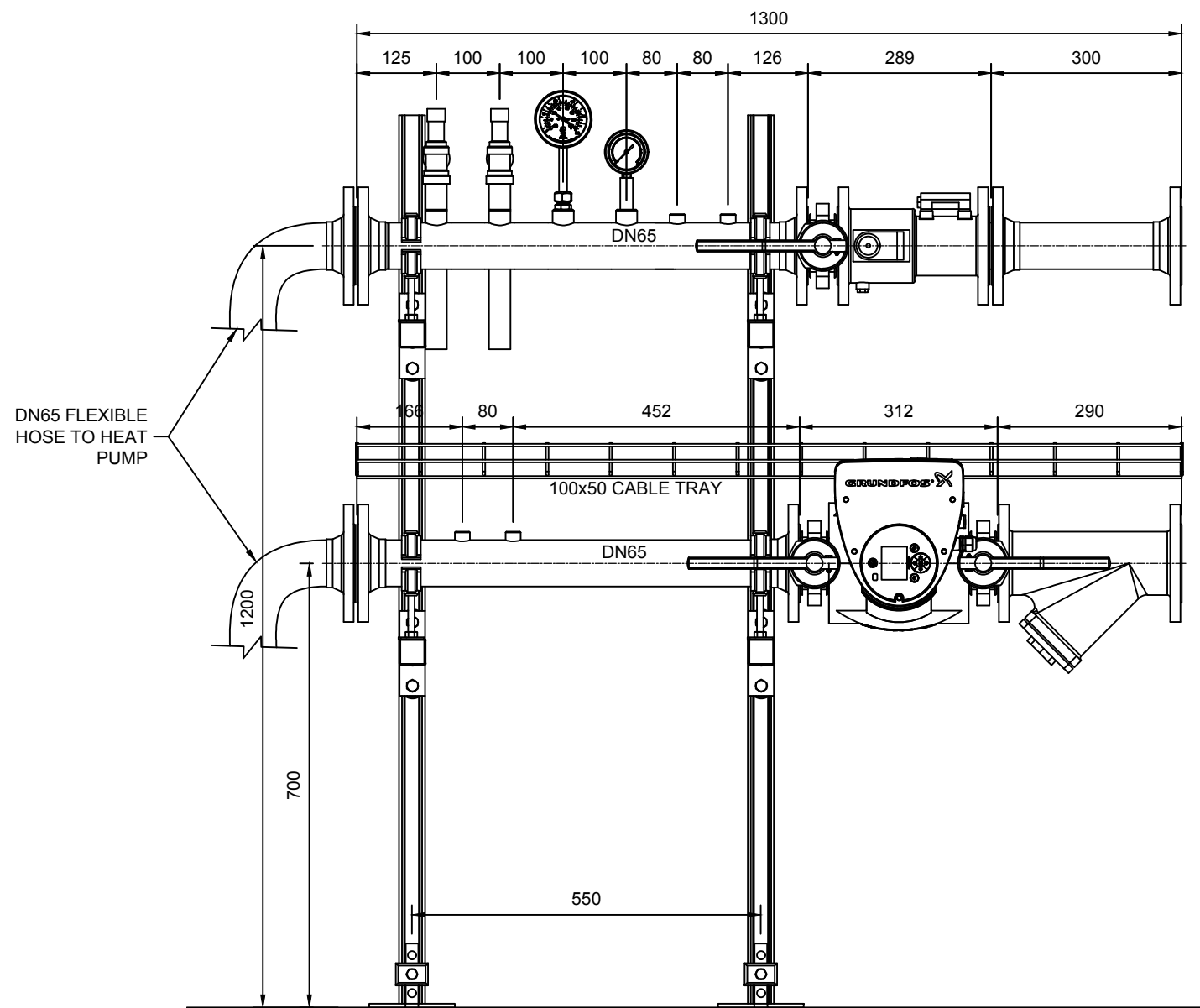

ELEVATION

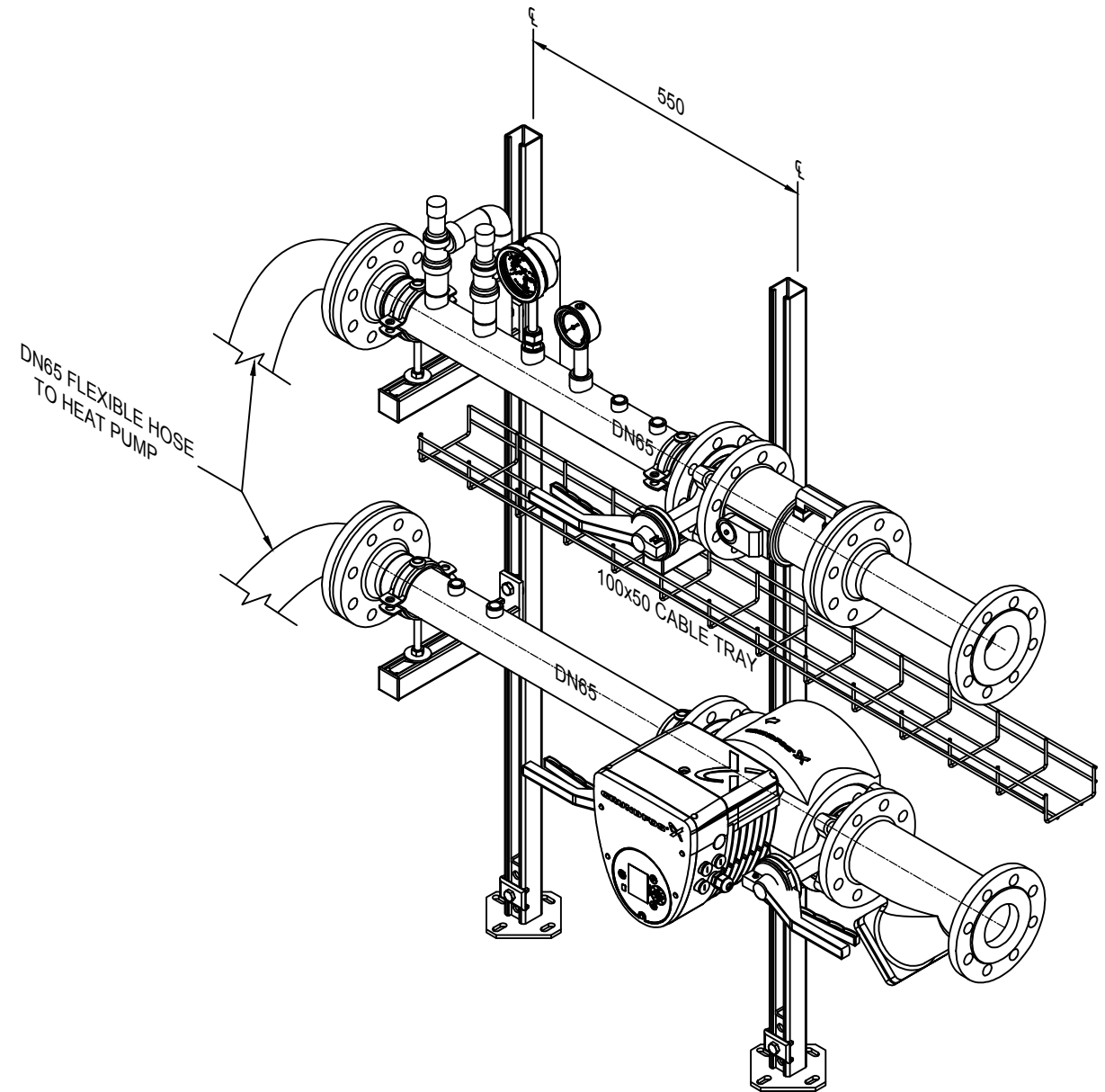

NOTE: ALL DIMENSIONS ARE IN MM UNLESS OTHERWISE STATED.



DRAWN:
ALIHASAN
CHECKED:
DATE:
10-05-2018

MODULE - 1
SKID GENERAL ARRANGEMENT

REV	DATE	DESCRIPTION	DRAWING NO.
			DWG-001
			SCALE 1:10